

INTERCONNECTION DIAGRAM

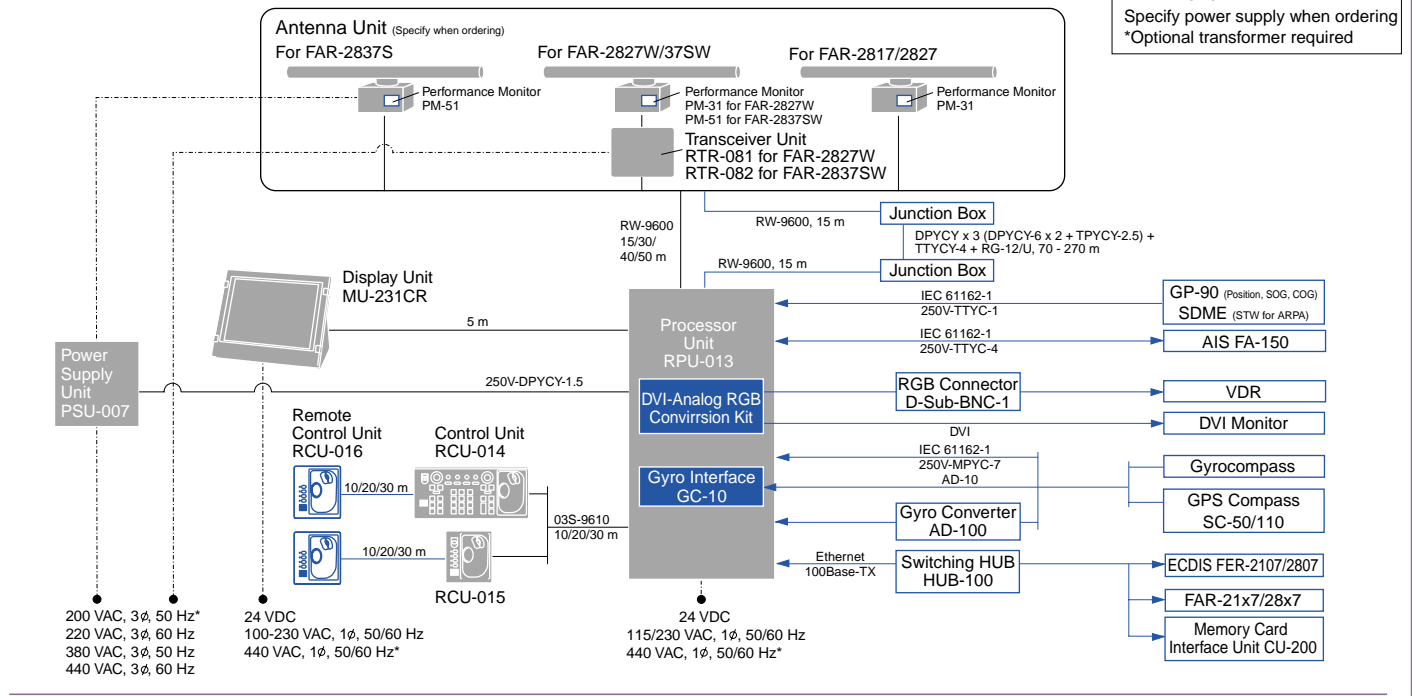

Antenna Unit for FAR-2817/2827/2827W

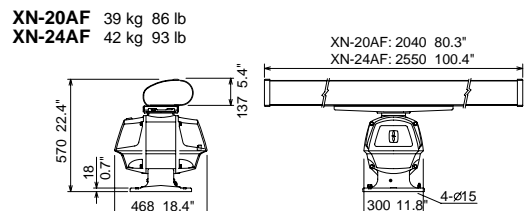
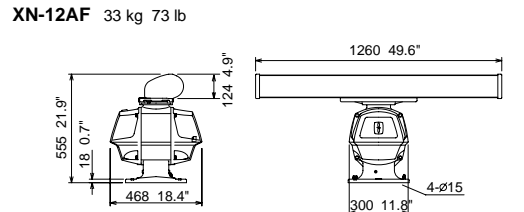

Display Unit MU-231CR 15.0 kg 33.0 lb

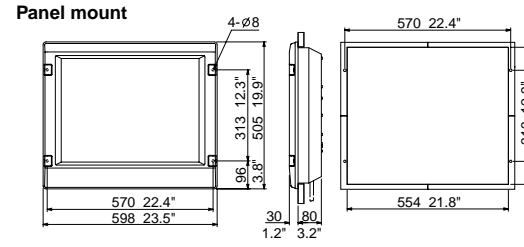
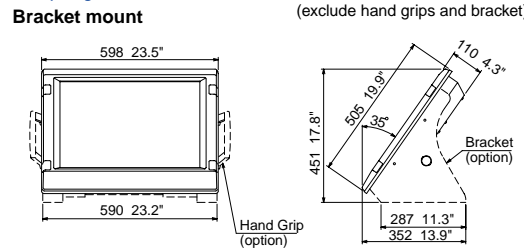

Antenna Unit for FAR-2837S/2837SW

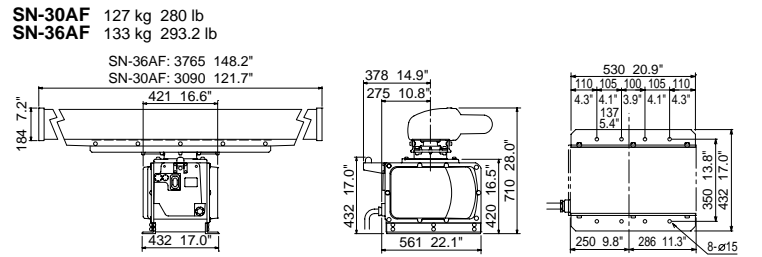

Transceiver Unit for FAR-2827W

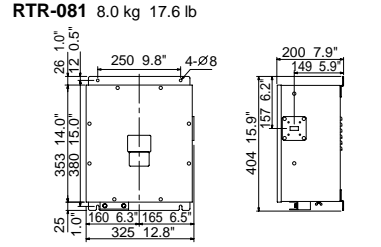

Transceiver Unit for FAR-2837SW

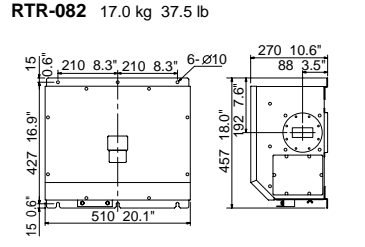

Processor Unit RPU-013 10 kg 22 lb

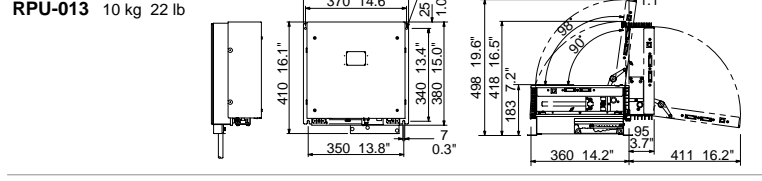

Control Unit Full-keyboard type RCU-014 3.7 kg 8.2 lb

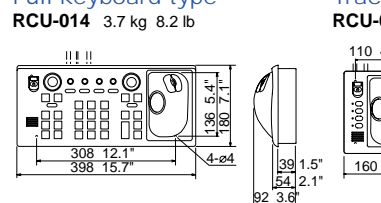

Trackball type RCU-015 2.4 kg 5.3 lb

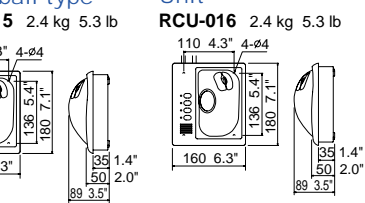

Remote Control Unit RCU-016 2.4 kg 5.3 lb

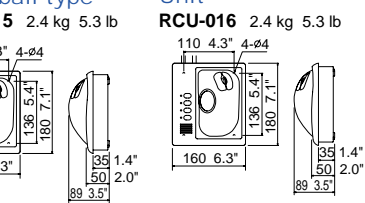

TRADE MARK REGISTERED MARCA REGISTRADA
SPECIFICATIONS SUBJECT TO CHANGE WITHOUT NOTICE

FURUNO U.S.A., INC.
Camas, Washington, U.S.A.
Phone: +1 360-834-9300
Fax: +1 360-834-9400

FURUNO ESPAÑA S.A.
Madrid, Spain
Phone: +34 91-725-90-88
Fax: +34 91-725-98-97

FURUNO SVERIGE AB
Västra Frölunda, Sweden
Phone: +46 31-7098940
Fax: +46 31-497093

FURUNO DEUTSCHLAND GmbH
Rellingen, Germany
Phone: +49 4101 838 0
Fax: +49 4101 838 111

FURUNO (UK) LIMITED
Denmead, Hampshire, U.K.
Phone: +44 2392-230303
Fax: +44 2392-230101

FURUNO DANMARK AS
Hvidovre, Denmark
Phone: +45 36 77 45 00
Fax: +45 36 77 45 01

FURUNO FINLAND OY
Espoo, Finland
Phone: +358 9 4355 670
Fax: +358 9 4355 6710

LLC FURUNO EURUS
Petersburg, Russia
Phone: +7 812 767 15 92
Fax: +7 812 766 55 52

FURUNO FRANCE S.A.
Bordeaux-Mérignac, France
Phone: +33 5 56 13 48 00
Fax: +33 5 56 13 48 01

FURUNO NORGE A/S
Ålesund, Norway
Phone: +47 70 102950
Fax: +47 70 127021

FURUNO POLSKA Sp.z o.o.
Gdynia, Poland
Phone: +48 58 669 02 20
Fax: +48 58 669 02 21

PRINTED WITH SOY INK. 05125U Printed in Japan



FURUNO®

RADAR/ARPA
Automatic Radar Plotting Aid

23.1" High resolution Multi-color LCD
FAR-28x7 series



The future today with FURUNO's electronics technology.
FURUNO ELECTRIC CO., LTD.
9-52 Ashihara-cho, Nishinomiya City, Japan Phone: +81 (0)798 65-2111
Fax: +81 (0)798 65-4200, 66-4622 URL: www.furuno.co.jp

Catalogue No. R-185e
TRADE MARK REGISTERED
MARCA REGISTRADA

**FURUNO has integrated leading-edge technology
with a user-friendly interface,
providing reliable performance and
simplified installation**

RADAR/ARPA
Automatic Radar Plotting Aid



The revolutionary FAR-28x7 series of X- and S-band, TR-up and -down radars are the result of FURUNO's 50 years of experience in marine electronics and advanced computer technology. This series is designed to meet the exacting standards of the International Maritime Organization (IMO) for all ships.

The display unit employs a 23.1" LCD which provides an effective picture diameter of larger than 340 mm. The high-resolution UXGA, digital flat-panel display unit provides crisp and clear radar images through a DVI interface. The DVI interface provides a pure digital video signal by using a digital signal for the entire path which maintains the image quality at the highest level, because the signal is not degraded as a result of a digital-to-analog conversion. The display has selectable color with a day and night background colors for clear presentation in all lighting conditions. Different colors are assigned for marks, symbols and text for easy observation.

Target detection is improved by sophisticated signal processing techniques featuring superb short-range detection. Two guard zones are provided as automatic acquisition zones for ARPA. One of two can be set at required ranges and any sector in any form. The FAR-28x7 series can display data about AIS-equipped ships, when connected with an AIS transponder. AIS enhances detection of other ships and AtoN (Aid to Navigation) on radar by displaying their movement and status with easy to read symbols and text.

The radar antenna is available with 4, 6.5, or 8 feet radiator. For the X-band, the rotation speed is selectable from 24 rpm for standard radars or 42 rpm for HSC. The S-band radar is also available with the antenna radiator of 10 or 12 feet. The S-band radar assures target detection in adverse weather where an X-band is heavily affected by sea or rain clutter.

**X-band antenna
for FAR-2817/2827/2827W**



8 ft antenna
(4 or 6.5 ft also available)



**S-band antenna
for FAR-2837S/2837SW**



10 ft antenna
(12 ft also available)



FAR-2817:	X-band, 12 kW, TR up
FAR-2827:	X-band, 25 kW, TR up
FAR-2827W:	X-band, 25 kW, TR down
FAR-2837S:	S-band, 30 kW, TR up
FAR-2837SW:	S-band, 30 kW, TR down



With optional mounting bracket and connection stand

With optional white, slim pedestal

- ▶ Advanced signal processing for improved target detection
- ▶ High resolution UXGA LCD provides crisp radar images
- ▶ Complies with the existing IMO standards for all ships
- ▶ Low spurious magnetrons meeting ITU-R unwanted emission standards
- ▶ Up to four radars can be interswitched in the network without an extra device
- ▶ Automatic plotting/tracking of 100 targets manually or automatically acquired
- ▶ Displays 1000 AIS-equipped targets
- ▶ Easy operation by customizable function keys, trackball/wheel palm module and rotary controls
- ▶ Stylish streamlined design

This series of radar complies with the following IMO and IEC regulations:

- IEC 60936-1 Shipborne radar
- IEC 60936-2 HSC radar
- IEC 60936-5 Use and display AIS information
- IEC 60872-1 ARPA
- IEC 60872-2 ATA
- IEC 61993-2 AIS
- IEC 60945 General requirements
- IEC 61162-1 ed 2 Digital interface
- IEC 61162-2 ed 1 Digital interface
- IMO MSC.64(67) Annex 4
- IMO A.823(19)
- IMO MSC.74(69) Annex 3



Utilizing a high speed Ethernet network, the FAR-28x7 series brings flexible system expansion and consolidation to onboard navigation systems

FEATURES of FAR-28x7 series

► 100 Base-TX Ethernet Network System

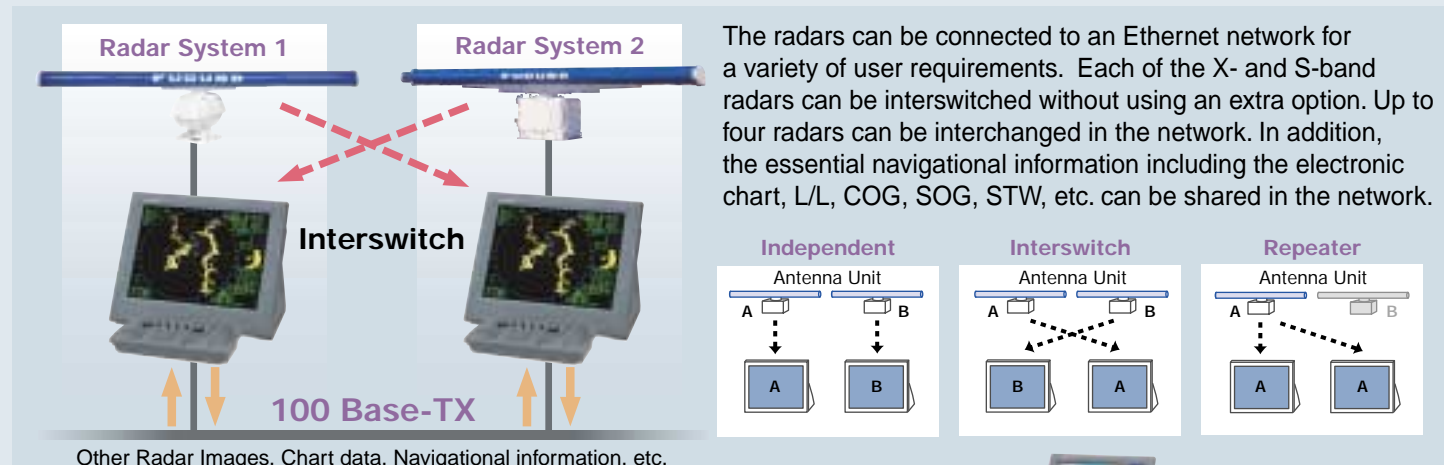

The 100 Base-T Ethernet is utilized to link up to four sets of radar/ARPA FAR-21x7/28x7 with the ECDIS FEA-2107/2807. This link gives high-speed navigational data sharing within the system and allows operators to choose either a single station system or a total Integrated Navigation System (INS).

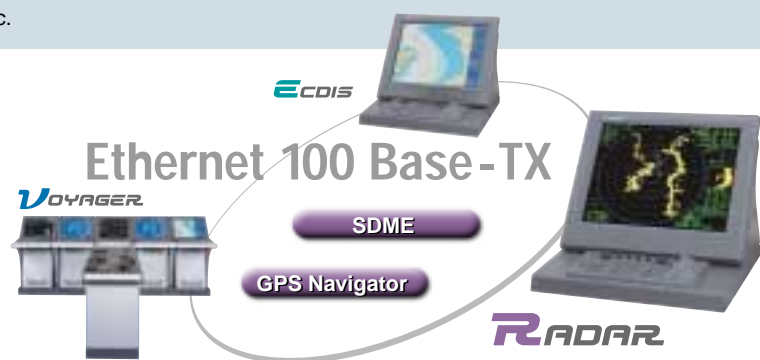

► Stress-free operation with versatile control units

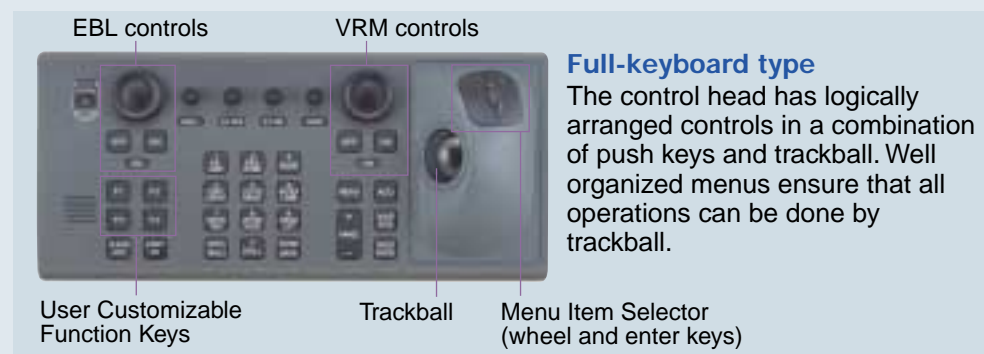

FUNCTIONS of FAR-28x7 series

► ARPA/AIS

Own ship data cell

DATA Cell 1	Tracking data	Water temp, Depth, Wind
DATA Cell 2	Tracking data	Zoom
DATA Cell 3	Tracking data	AIS Information

Data Display
A variety of navigational information, own ship status, radar plotting data, wind, water temperature and information from other shipborne sensors are displayed on the cells. The FAR-28x7 series has an unique zoom function, which enlarges a part of the radar image twice or three times in size.

Target Association (Fusion)

An AIS-equipped ship may be displayed by both AIS and ARPA symbols. This is because the AIS position is measured by a GPS navigator in L/L while the ARPA target blip and data are measured by range and bearing from own ship. When the symbols are within an operator-set criteria, the ARPA symbol is merged with the AIS symbol. The criteria is determined by the differences in range, bearing, course, speed, etc.

Symbols for AIS

AIS COG/SOG vector changes its length with speed. ROT mark is viewable at the COG/SOG vector tip when a target ship is equipped with a FURUNO satellite compass SC-50/110 or gyrocompass which can talk ROT serial sentence.

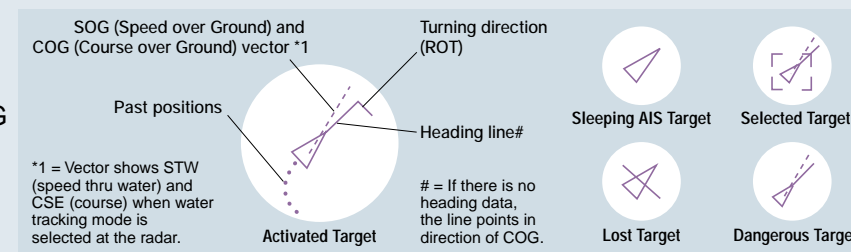

Guard Zones

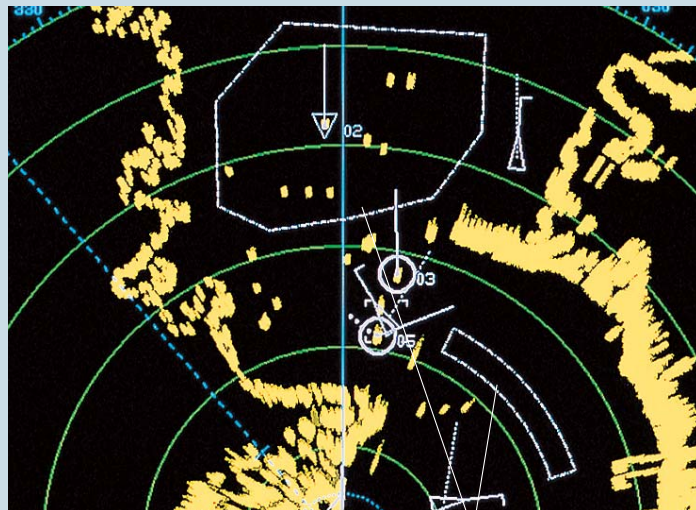

Guard Zones

Automatic Acquisition Zone

Two automatic acquisition zones may be set in a sector or any form. They also act as suppression zones, avoiding unnecessary overloading to the processor and clutter by disabling automatic acquisition and tracking outside them. Targets in an automatic acquisition zone are shown with an inverse triangle. The operator can manually acquire important targets without restriction.

Guard Zones and Anchor Watch Zone

Guard Zones generate visual and audible alarms when targets enter the operator set zones. One of the Guard Zones may be used as an anchor watch to alert the operator when own ship or targets drift away from the set zone.

CPA Alarm

The target tracking symbol changes to a triangle when its predicted course (vector) violates the operator set CPA/TCPA. The operator can readily change the vector lengths to evaluate the target movement trend.

Symbols for ARPA



Past Position Display

The ARPA displays equally time-spaced dots marking the past positions of any targets being tracked. A new dot is added during preset time intervals until the preset number is reached. AIS also displays past position dots.

Target Trails

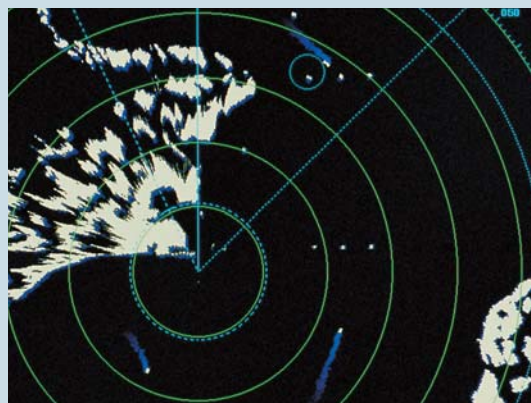

The target trails feature generates a monotone or gradual shading afterglow on all objects on the display. The trails are useful in showing own ship movement and other ship tracks in a specific fishing operation. The unique feature in this radar is a choice of True or Relative mode in Relative Motion (only True in TM). When changing modes, trails remain on the screen.

Chart Overlay



This radar incorporates a VideoPlotter that displays electronic charts (Navionics and FURUNO Charts), plots own and other ship's track, enables entry of waypoints/routes, and makes a radar map. The Radar targets are overlaid on the chart. (For non-SOLAS ships only)

Radar Map

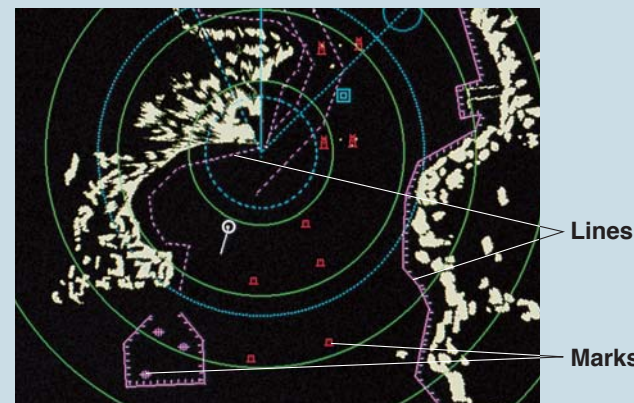

A radar map is a combination of lines and marks whereby the user can define and input the navigation area, route planning and monitoring data. The radar map can include up to 20,000 points for lines and marks. The map data can be saved to facilitate repeated use on a routine navigation area. Planned routes created on ECDIS can be transferred onto a radar display when interfaced with ECDIS.

Presentation Colors

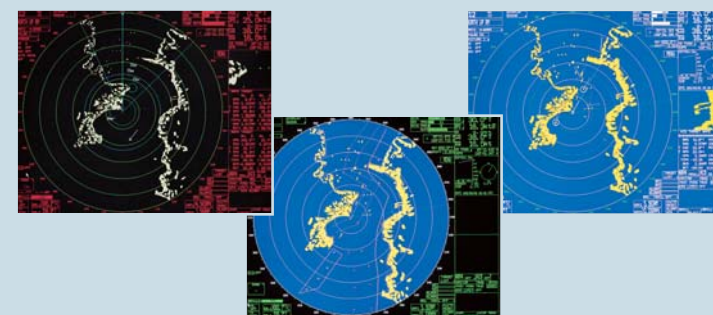

Antenna Radiators

1. Type Slotted waveguide array
2. Beamwidth and sidelobe attenuation

Radiator Type	X-Band			S-Band	
	XN-12AF	XN-20AF	XN-24AF	SN-30AF	SN-36AF
Length	4 ft	6.5 ft	8 ft	10 ft	12 ft
Beamwidth(H)	1.9°	1.23°	0.95°	2.3°	1.8°
Beamwidth(W)	20°	20°	20°	25°	25°
Sidelobe (within ± 10°)	-24 dB	-28 dB	-28 dB	-24 dB	-24 dB
Sidelobe (outside ± 10°)	-30 dB	-32 dB	-32 dB	-30 dB	-30 dB

S-band 10 ft radiator usable for an HSC

3. Rotation

X-Band		S-Band	
Rotation	24 rpm	42 rpm	
Gear Box	RSB-096/103	RSB-097	
S-Band		S-Band	
Rotation	21/26 rpm	45 rpm	
Gear Box	RSB-098/099/104/105	RSB-100/101/102	

RF Transceiver

1. Frequency

X-band: 9410 MHz ±30 MHz
S-band: 3050 MHz ±30 MHz

2. Output power

	FAR-2817	FAR-2827	FAR-2827W	FAR-2837S	FAR-2837W
Output Power	12 kW	25 kW	25 kW	30 kW	30 kW
Transceiver	RTR-078	RTR-079	RTR-081	RTR-080	RTR-082

3. Pulselength/PRR

Range scale (nm)	Pulselength (μs)	PRR (Hz)
0.125, 0.25	0.07	3000
0.5	0.07, 0.15	3000
0.75, 1.5	0.07, 0.15, 0.3	3000, 1500
3	0.15, 0.3, 0.5, 0.7	3000, 1500, 1000
6	0.3, 0.5, 0.7, 1.2	1500, 1000, 600
12, 24	0.5, 0.7, 1.2	1000, 600
48, 96	1.2	600

4. I.F.

60 MHz, Logarithmic

5. Bandwidth

Short pulse: 40 MHz
Middle pulse: 10 MHz
Long pulse: 3 MHz

RADAR DISPLAY

1. Display

23.1" color LCD (UXGA 1600 x 1200 pixels),
470 (H) x 353 (V) mm,
Effective display diameter: 340 mm
Echo Color: Yellow, green or white in 32 levels

2. Range scales and ring intervals (nm)

Range	.125, .25, .5, .75, 1.5, 3, 6, 12, 24, 48, 96
Ring	.025, .05, .1, .25, .5, 1, 2, 4, 8, 16

3. Minimum range

30* m on 0.75 nm range scale

*Using a 10 m² test target at 3.5 m high above sea and antenna at 15 m high (IEC 60936-1). Different conditions give a different result, maybe close to 20 m in actual installations.

4. Range discrimination

35 m

5. Range ring accuracy

1% of the maximum range of the scale in use or 30 m, whichever is the greater

6. Presentation modes

Head-Up, Course-Up, North-Up, North-Up TM

7. Heading information

GPS compass SC-50/110 is a recommendable heading sensor as a backup for a gyrocompass. Confirm if your Administrations permit its use.

8. Parallel index lines

1, 2, 3 or 6 lines (menu selectable)

9. Radar map

20,000 points to create coastlines, own ship safety contour, isolated underwater dangers, buoys, traffic routing systems, prohibited areas and fairways as required by IMO.

Automatic Plotting

1. Acquisition

100 targets (e.g., manually 50, automatically 50)

2. Tracking

Automatic tracking of all acquired targets in 0.1 to 32 nm

3. Guard zone (Target Acquisition Area)

Two guard zone, one of them 0.5 nm depth

4. Vector

True or relative, 30 s, 1, 3, 6, 12, 15, 30 min for prediction of target motion

5. Past positions

5 or 10 past positions at intervals of 30 s, 1, 2, 3, 6 min.

6. Collision warning

CPA limit: 0.2 - 10 nm, TCPA limit: 0 - 99 min.

7. Trial maneuver

Dynamic or static, with selected delay time.

AIS FUNCTIONS (Data input from AIS is required)

1. Symbols

Sleeping, Activated, Dangerous, Selected, Lost targets

2. Number of targets

1,000 targets max.

3. Data indication

Basic and expanded data

POWER SUPPLY (specify when ordering)

1. Processor Unit

24 VDC or 115/230 VAC, 1ø, 50/60 Hz
440 VAC, 1ø, 50/60 Hz with optional transformer RU-1803

2. Display Unit

24 VDC or 100-230 VAC, 1ø, 50/60 Hz
440 VAC, 1ø, 50/60 Hz with optional transformer RU-1803

3. Antenna Unit

FAR-2837S/2837SW:
200 VAC, 3ø, 50 Hz; 220 VAC, 3ø, 60 Hz; 380 VAC, 3ø, 50 Hz;
440 VAC, 3ø, 60 Hz; 110 VAC, 3ø, 60 Hz with RU-5693;
220 VAC, 3ø, 50 Hz with RU-6522;
440 VAC, 3ø, 50 Hz with RU-5466-1

EQUIPMENT LIST

Standard

1. Display Unit MU-231CR
2. Processor Unit RPU-013
3. Full-keyboard Control Unit RCU-014
Trackball Control Unit RCU-015
(Specify when ordering)
4. Antenna Unit with cable (15/30/40/50 m)
5. Power Supply Unit PSU-007 for FAR-2837S
6. Standard Spare Parts and Installation Materials

Option

1. Performance Monitor PM-31 for X-band,
PM-51 for S-band
2. Remote Control Unit RCU-016
3. Gyro Interface GC-10
4. DVI-Analog RGB Conversion Kit OP03-180
5. RGB Connector DSUB-BNC-1 (for VDR)
6. Memory Card Interface Unit CU-200
7. Transformer RU-1803/5466-1/5693/6522
8. Rectifier RU-3424/1746B
9. Junction Box RJB-001
10. Antenna Cable RW-9600
11. Hand Grip FP03-09840
12. Bracket FP03-09820
13. Switching Hub HUB-100